

Tavole roto-basculanti cnc CNC Tilting rotary tables

Trasmissione meccanica
Bloccaggio pneumatico

Mechanical transmission
Pneumatic clamping

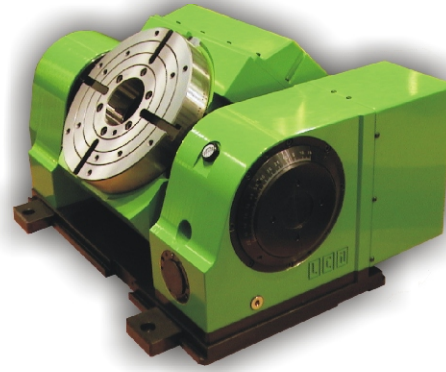

Caratteristiche - Modelli Specifications - Models		BSC 125		BSC 200		BSC 250		BSC 320	
Diametro tavola Table diameter	mm.	125		198		248		318	
Diametro foro centrale Center bore	mm.	28		42		72		81	
Altezza punta Center height	mm.	127		151		180		235	
Larghezza cave a T Table T-slots width	mm.	6		9,7		11,7		13,7	
Inclinazione Tilt range		-10° ÷ 110°		-10° ÷ 110°		-10° ÷ 100°		-10° ÷ 100°	
Asse Axis		Girevole Rotary	Inclinabile Tilting	Girevole Rotary	Inclinabile Tilting	Girevole Rotary	Inclinabile Tilting	Girevole Rotary	Inclinabile Tilting
Sistema di bloccaggio Clamp system		Pneumatico Pneumatic	Pneumatico Pneumatic	Pneumatico Pneumatic	Pneumatico Pneumatic	Pneumatico Pneumatic	Pneumatico Pneumatic	Pneumatico Pneumatic	Pneumatico Pneumatic
Capacità di bloccaggio Clamp torque	Nm.	250	400	400	600	600	1200	1000	1600
Rapporto vite/corona Worm screw/wheel ratio		1/180	1/180	1/180	1/120	1/180	1/180	1/180	1/240
Grandezza motore (pagina 43) Servo motor size (page 43)		1	1	2	3	3	3	4	4
Velocità massima di rotazione Max rotation speed	Rpm	16,6	16,6	16,6	25	16,6	16,6	16,6	12,5
Precisione di posizionamento Indexing accuracy	sec.	± 15	± 30	± 15	± 30	± 15	± 30	± 15	± 30
Incremento minimo Minimum increase		0,001°		0,001°		0,001°		0,001°	
Peso max ammesso 0° Max allowable load 0°	Kg.	45		95		130		220	
Peso max ammesso 90° Max allowable load 90°	Kg.	25		45		90		110	
Spinta max ammessa 0° Max allowable thrust 0°	N.	4600		8600		10300		13100	
Spinta max ammessa 90° Max allowable thrust 90°	FxL Nm	125		370		650		830	
Coppia di lavoro Working torque	Nm	124		194		254		630	
Peso netto tavola Table net weight	Kg.	58		88		140		322	

BSC 125

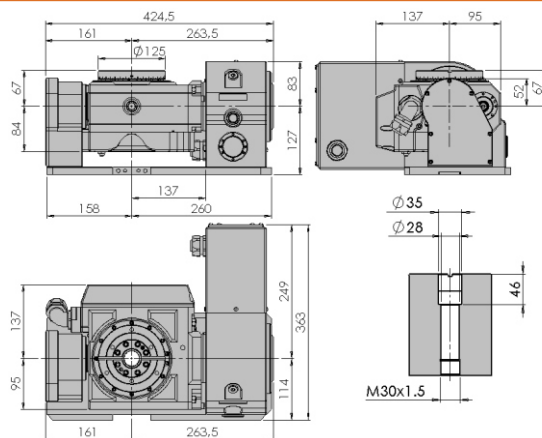
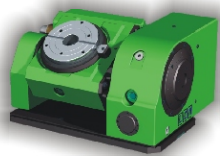

BSC 200

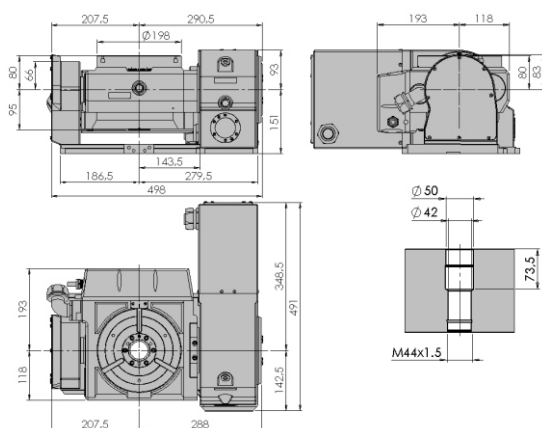
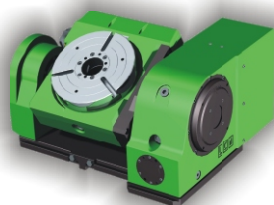

BSC 250

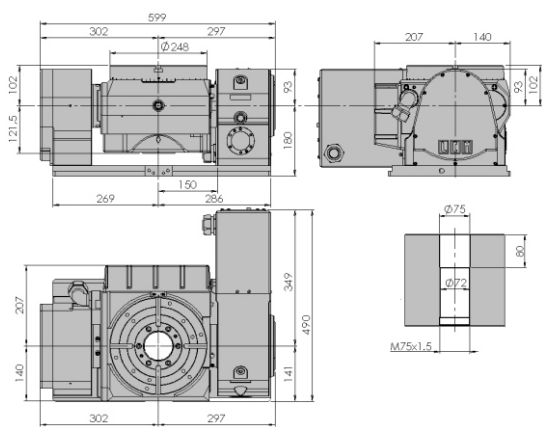
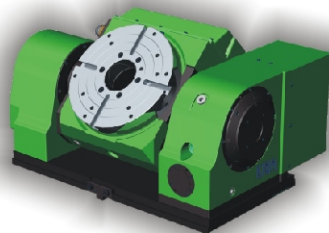

BSC 320

