

Tavole girevoli cnc con motore coppia Cnc Rotary tables with torque motor

Motore coppia
Bloccaggio idraulico

Torque motor
Hydraulic clamping







Le tavole serie TDE- T possono essere fornite con:

- Personalizzazione del piano tavola con scanalature a T diverse dallo standard, piattello liscio o fori filettati.
- Verniciatura con RAL specifico

The TDE-T table series can be supplied with:

- Personalization of the table surface with various T-slots, smooth plate, or threaded holes.
- Painted to specific RAL colour

Caratteristiche - Modelli Specifications - Models		TDE-TV 270	TDE-TV 400	TDE-TH 450	TDE-TH 600	TDE-TH 800 (1000)
Diámetro tavola Table diameter	mm.	270	400	450	610	800 (Opt.1000)
Diámetro foro centrale Center bore	mm.	75 X L=186	105 X L=201	50 X L=30	50 X L=30	60 X L=30
Altezza punte Center height	mm.	250	350	////	////	////
Larghezza cave a T Table T-slots width	mm.	12	14	14	18	22
Sistema di bloccaggio Clamp system		Idraulico Hydraulic	Idraulico Hydraulic	Idraulico Hydraulic	Idraulico Hydraulic	Idraulico Hydraulic
Capacità di bloccaggio Clamp torque (entry pressure)	Nm.	855 (50 Bar)	1960 (50 Bar)	1800 (50 Bar)	3000 (40 Bar)	5000 (40 Bar)
Coppia nominale (S1) Continuous torque (S1)	Nm.	345	540	400	880	1240
Coppia massima (S6) Peak torque (S6)	Nm.	580	990	710	1660	2330
Velocità massima di rotazione Max rotation speed	Rpm	150	120	130	100	90
Precisione di posizionamento Indexing accuracy	sec.	±5	±5	±5	±5	±5
Peso max ammesso Max allowable load	 Kgf	400	1300	////	////	////
Spinta max ammessa Max allowable thrust	 F x L Nm	1900	2500	3000	4900	6000
Peso max ammesso orizzontale Max allowable load horizontal	 Kgf	////	////	1300	2000	2500
Spinta max ammessa orizzontale Max allowable thrust horizontal	 N	////	////	30000	65000	80000
Peso netto tavola Table net weight	Kg.	200	315	270	620	1050

Motore coppia
Torque motor



Tavole girevoli cnc con motore coppia
Cnc Rotary tables with torque motor

Motore coppia
Bloccaggio idraulico

Torque motor
Hydraulic clamping

TDE-TV 270

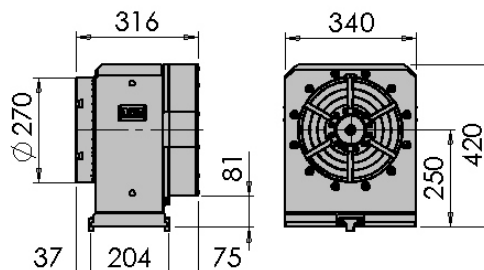
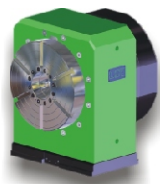

TDE-TV 400

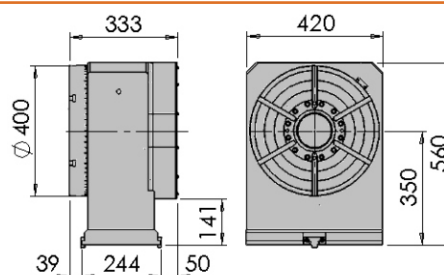
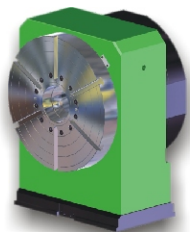

TDE-TH 450

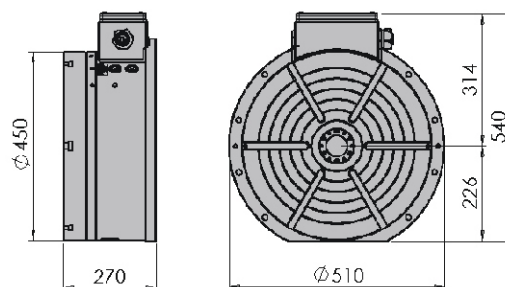
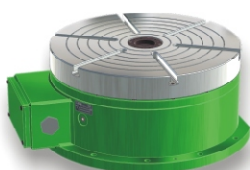

TDE-TH 600

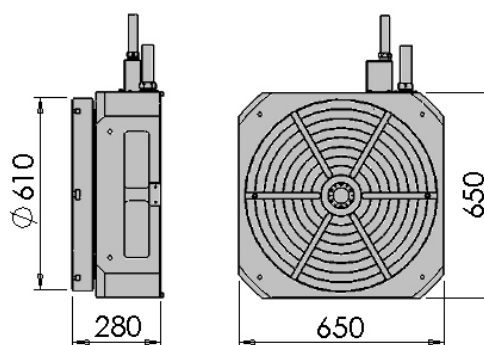
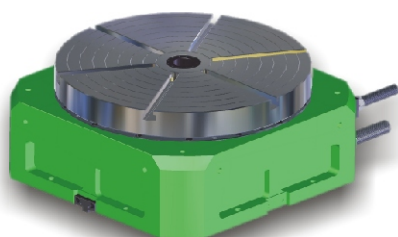

TDE-TH 800 (1000)

